

Office of the Mayor
PROCLAMATION

ANTHONY VUOLO

WHEREAS, Anthony Vuolo, a resident of Midland Park for forty years, has devoted much of his adult life to the service of our town; and

WHEREAS, His desire to serve the community began in 1963 when he founded the Junior Football League. Tony started many other recreation programs including Power Puff Softball, Mens's Softball, and a long time favorite town wide event - Olympic Day.

WHEREAS, Tony has served on the Board of Recreation from 1974-2001, and is well known for his outstanding ability to organize and run events.

WHEREAS, Tony, on many occasions, has shared his leadership, organizational skills and artistic talent to serve the school community. In 1964 he started the High School Booster Club and organized many football dinners. Tony also played the role of Art Director for a number of High School Graduation Balls.

WHEREAS, Tony's labor of love to serve the community and his eagerness to help others has resulted in beautification of a number of public areas in the Borough.

WHEREAS, Tony has served the community as a State Police Officer for 31 years. He was granted the "Top Cop" Award, and for his outstanding leadership qualities, appointed the "Citizen of the Year" in Midland Park in 1981.

NOW, THEREFORE, BE IT RESOLVED: That ANTHONY VUOLO be commended for his many years of hard work and selfless dedication to the citizens of Midland Park and of Bergen County; and

BE IT FURTHER RESOLVED, That I, on behalf of all our citizens, do hereby extend to ANTHONY VUOLO our sincere appreciation for his contributions to our community.

Given under my hand and seal this twenty fifth day of October,
in the year of our Lord, two thousand one.

Esther Vierheilig
ESTER VIERHEILIG, Mayor

03.12.2018



03.12.2018



03.12.2018



03.12.2018

NEWARK



N.J.S.P

03.19.2018













T. VUOLO





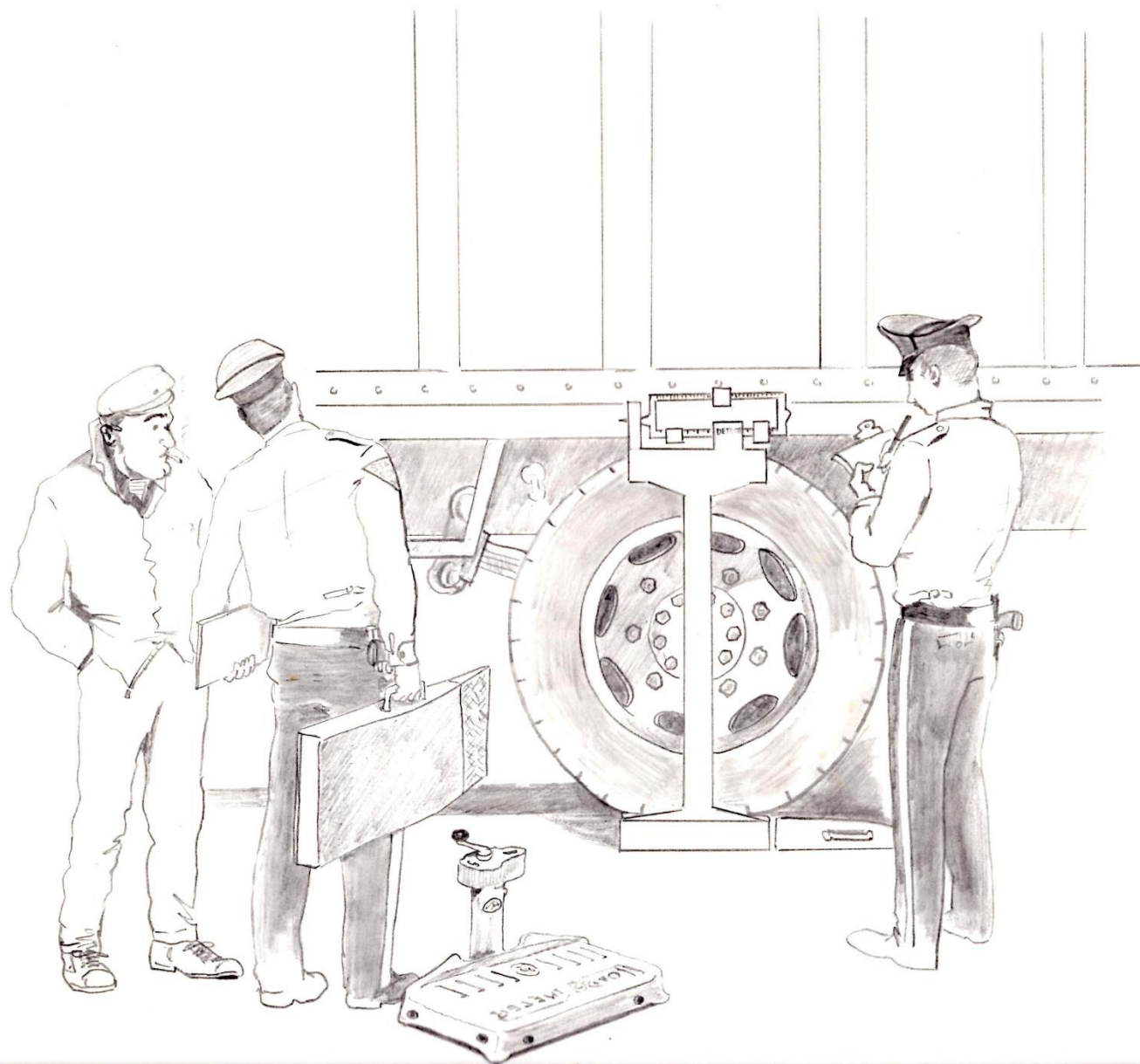



Logo For TEE SHIRTS





LT. COL. BILL BURKE SP

LT. COL. RAY SP

LT. COL. FRANK LADATCH

ALL THREE WERE BEING HONORED AT A DINNER IN SOMERSET N.J.
I WAS ASKED TO DRAW SOMETHING FOR THE DINNER (LAST MINUTE).

SP

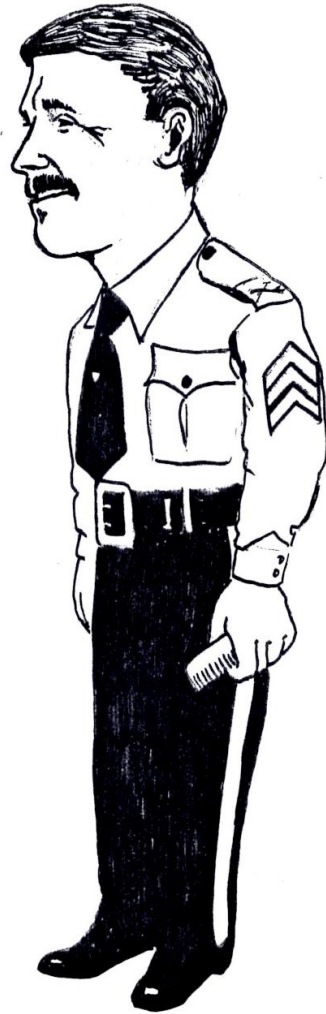

CARICATURE OF "CHICO WALZUSKY"

DRAWN FOR THE COVER OF A BOOK
WRITTEN BY LT. LOU JASMINE
CONCERNING A MURDER HE WORKED ON
WITH THE HE DETECTOR, INVOLVING
BITE MARKS -

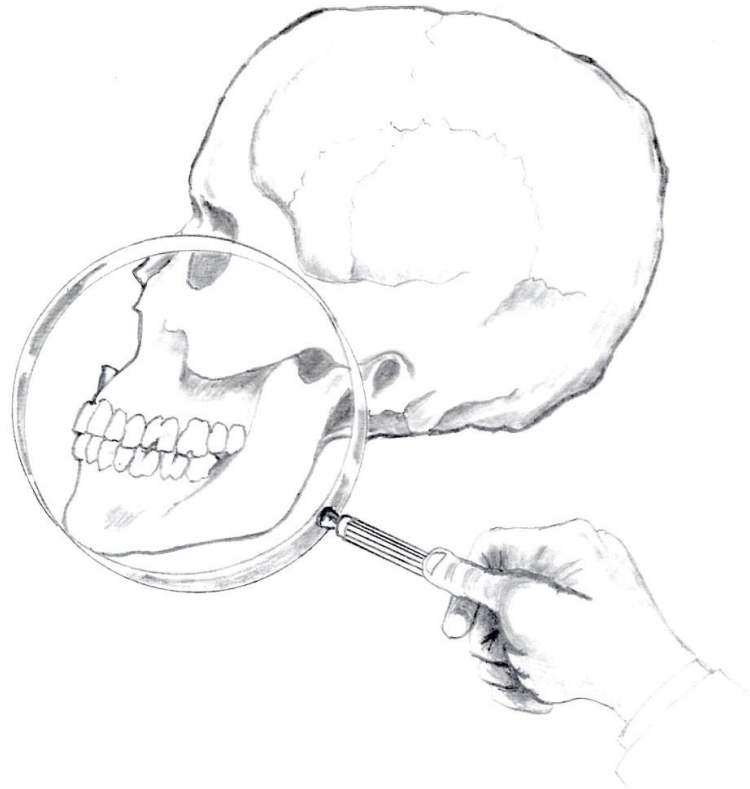





"DUI"



CARICATURE OF "ED REHALER"



WANT A GOOD ATTORNEY?
GO TO JAIL FOR ONE.....



SGT JIM BOJANSKY
(MONEY BAGS)
WE KIDDED HIM BE-
CAUSE HE OWNED A
LARGE APT. HOUSE...

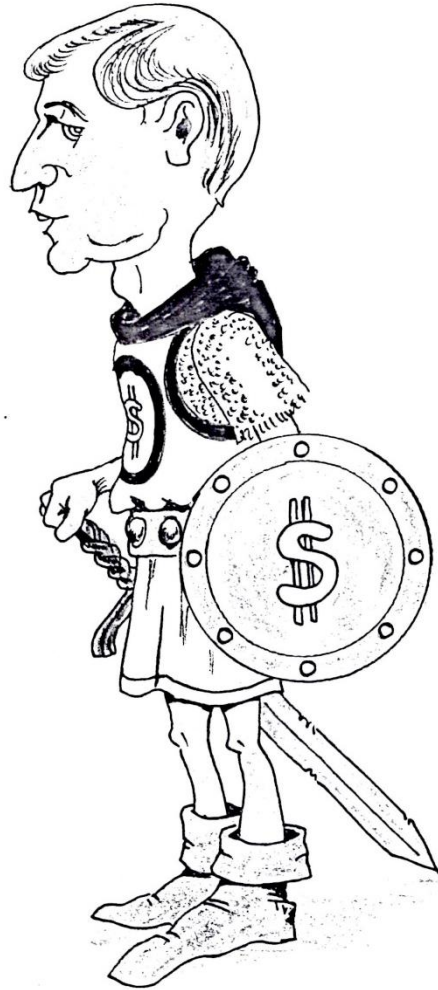

LT. JOHN NEELD "SIR MONEY BAGS"

CARICATURE OF
LT. JOHN O'CONNOR
A GOOD FRIEND
WE CALLED HIM
"TWINKLE TOES"



LT. JOHN PALLOTTA
HAD A NEIGHBOR WHO SAID HE
HIT A DEER ON THE WAY HOME -
HE PANICED, AND PLACED THE
SUPPOSED DEAD DEER IN HIS
TRUNK - BUT WHEN HE GOT
HOME & OPENED THE TRUNK,
THE DEER RAN AWAY...

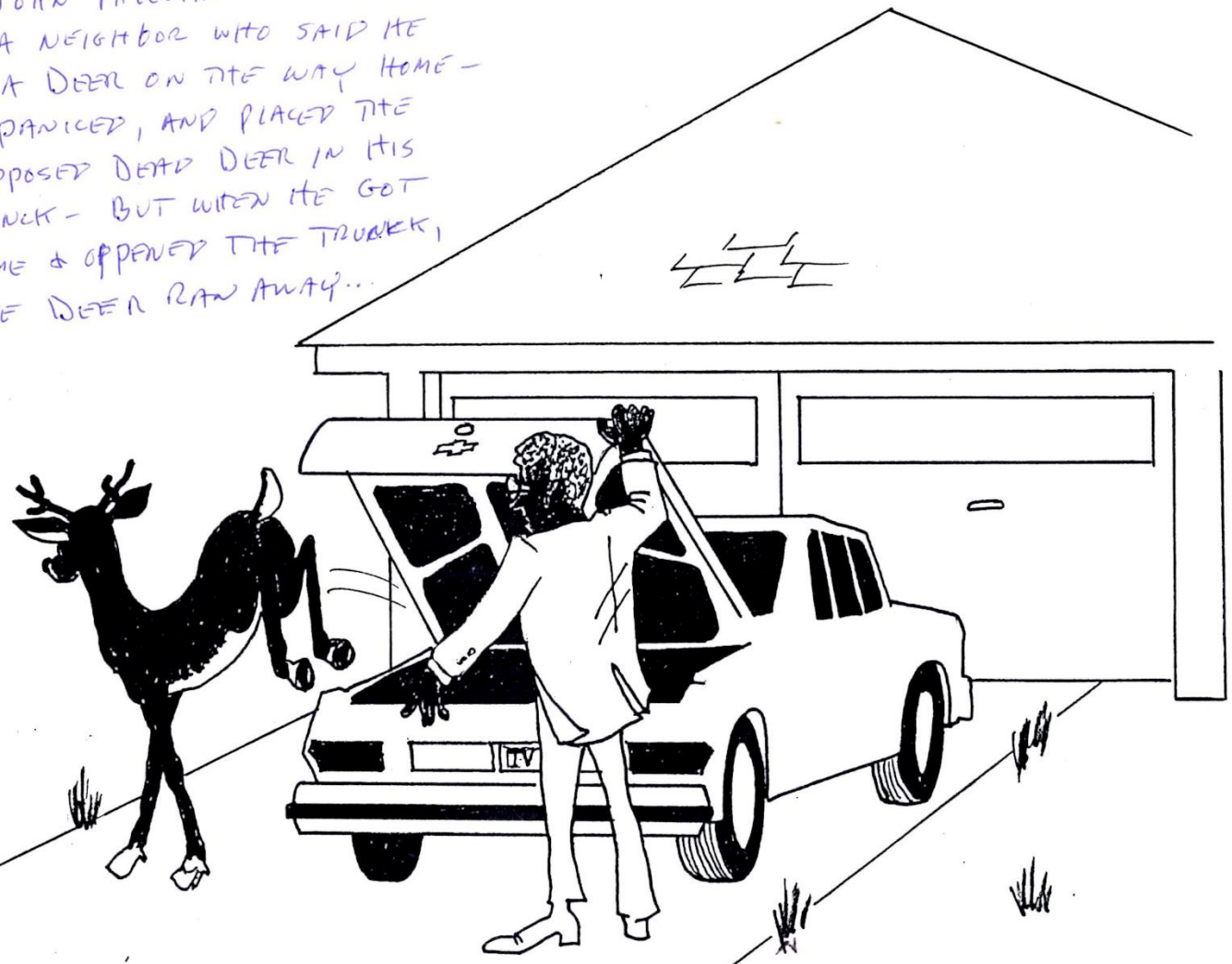



TPR. LOU ARCE
WORKED WITH ME AT N. BRUNSWICK STP



"Logo"

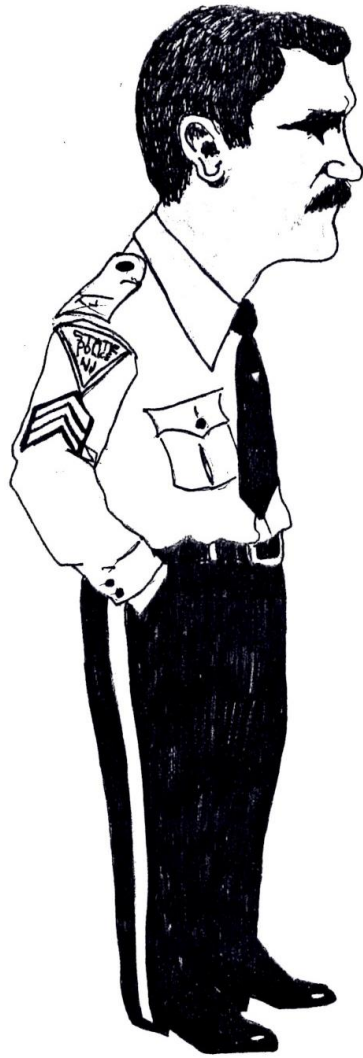

CARICATURE OF
PAUL MORRISON

11

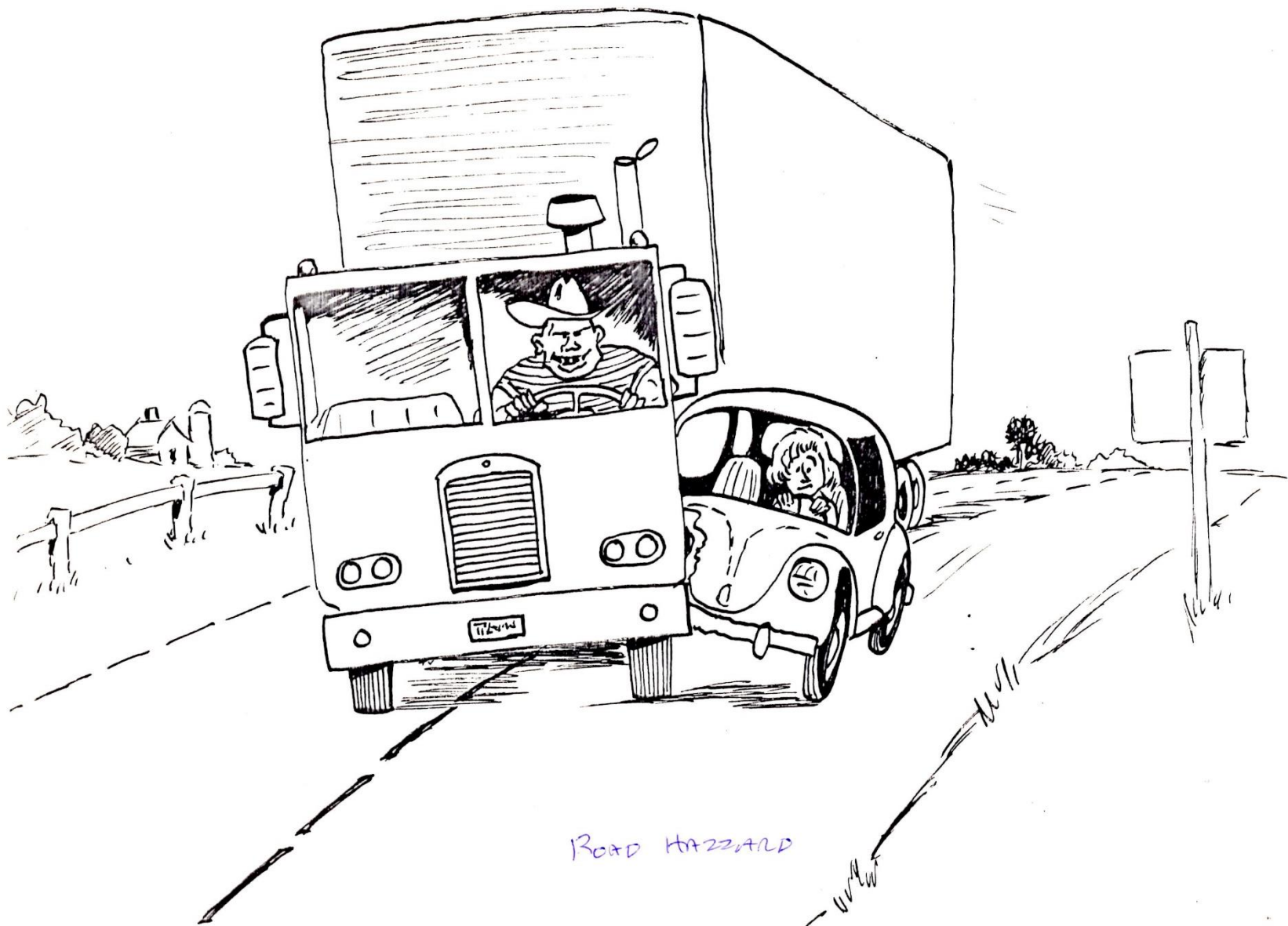

ROAD HAZARD

Ross BAYR

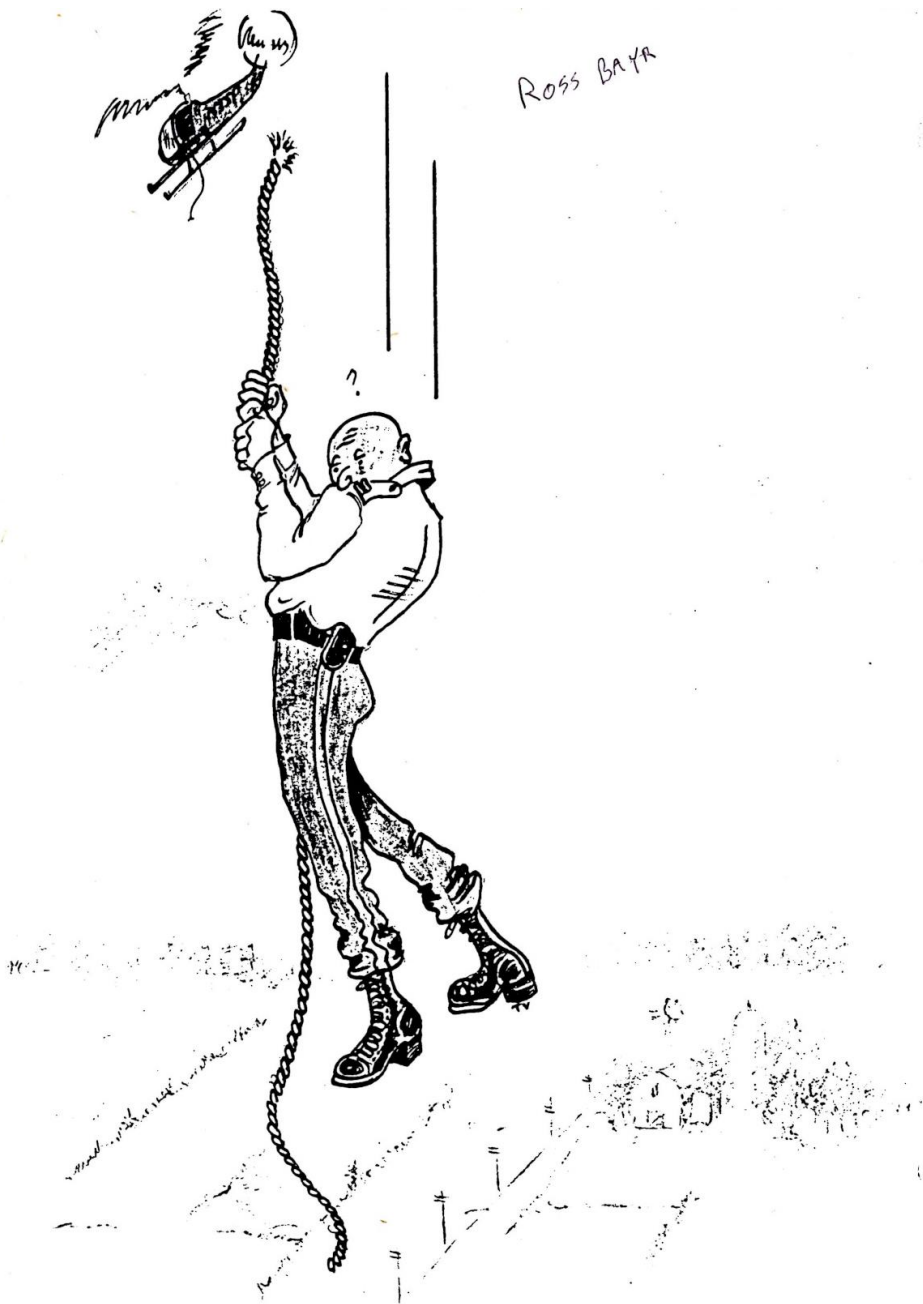

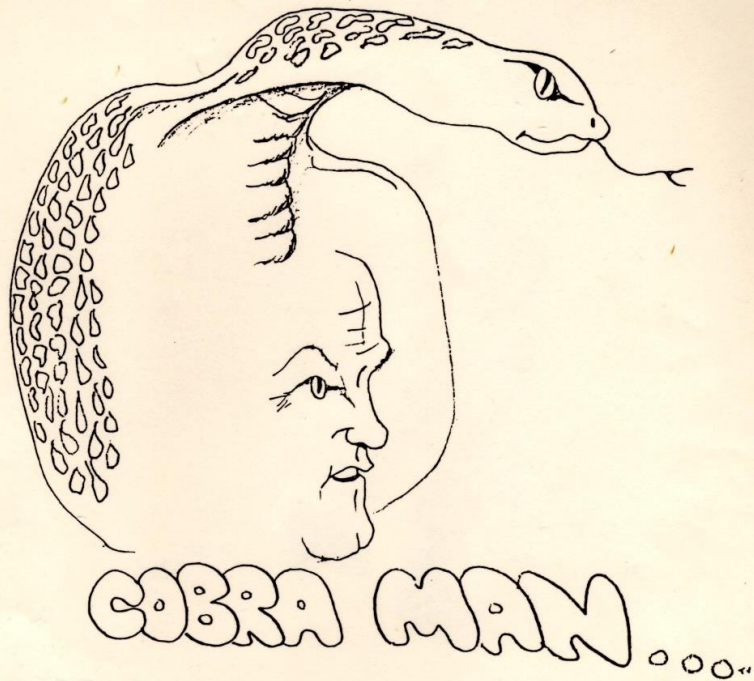

COBRA MAN...

LT. ROSS MACARTHUR.
WORKED W/ ME AT NEW BRUNSWICK
STATION



Logo for SWEATSHIRTS.

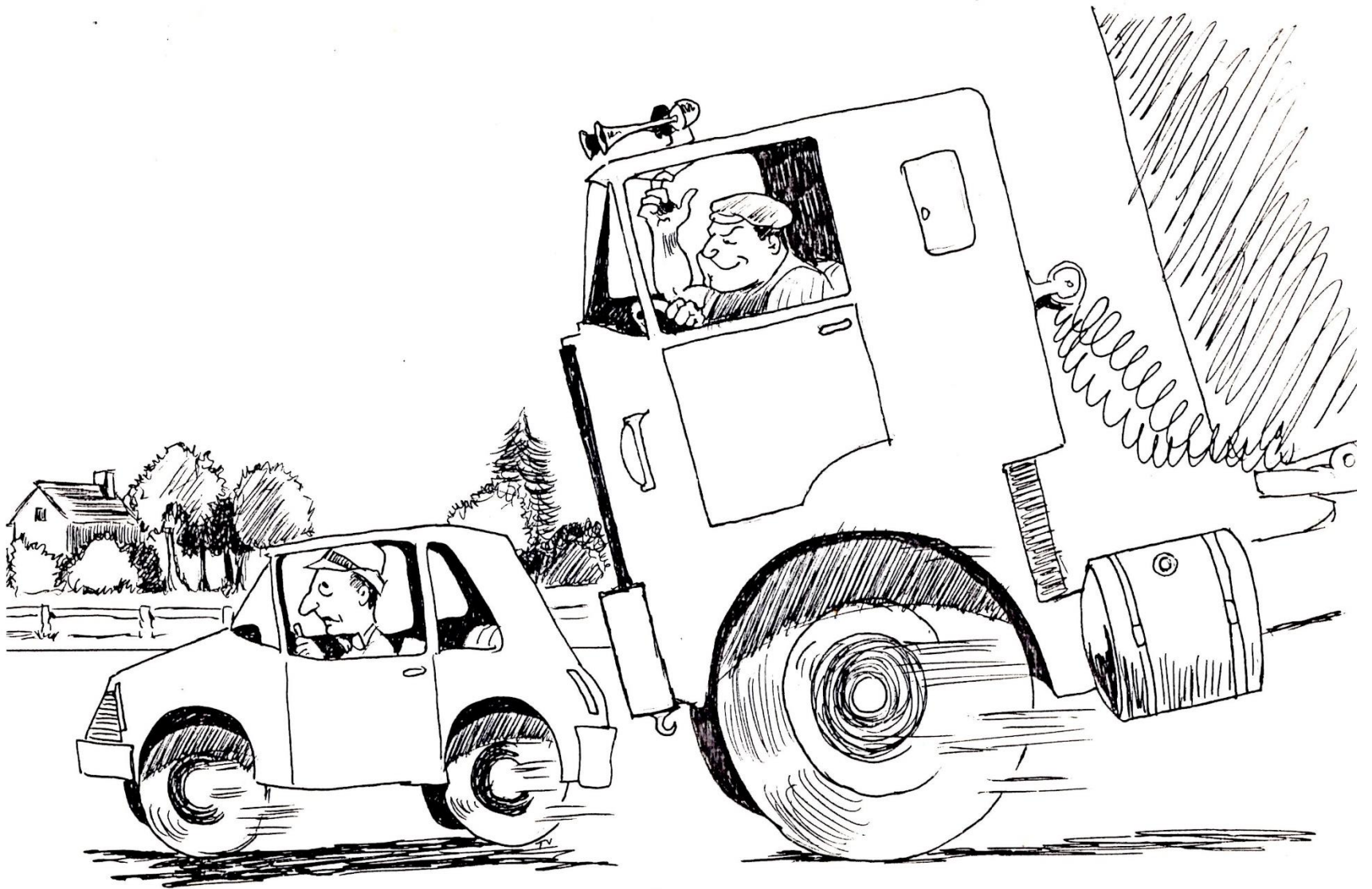

ROAD HAZZARD...

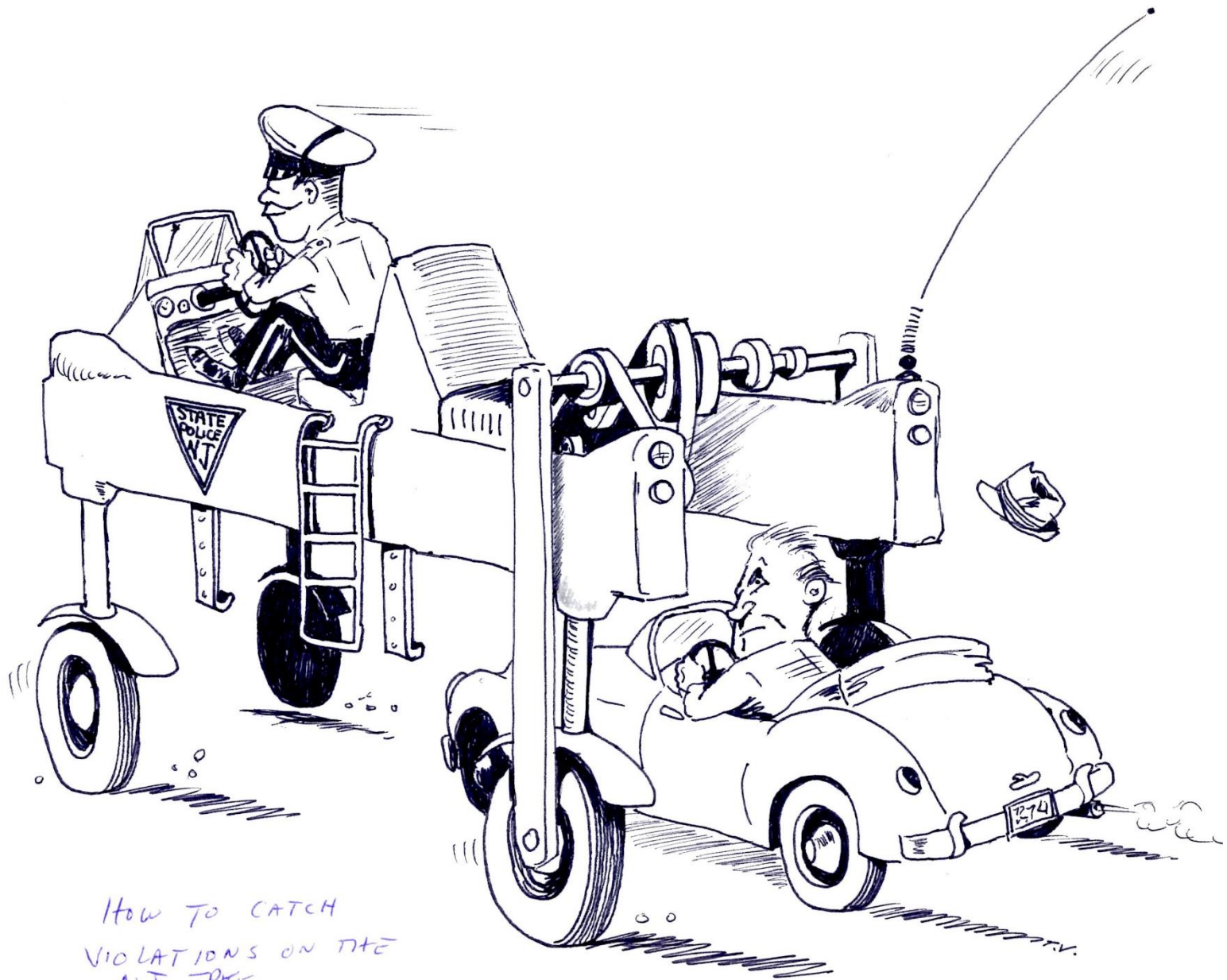

How to catch
violations on the
NJ TPKE.

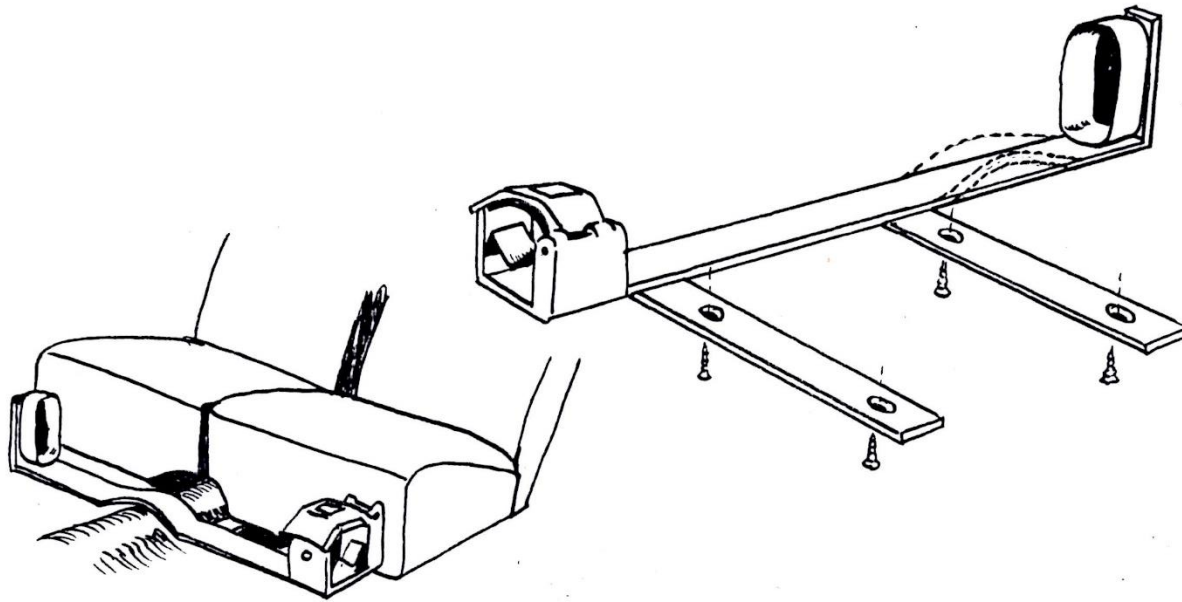
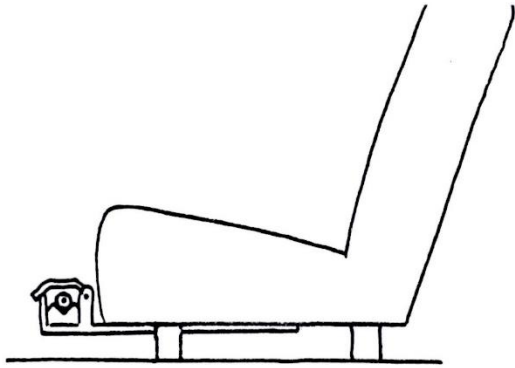

Gun Rack

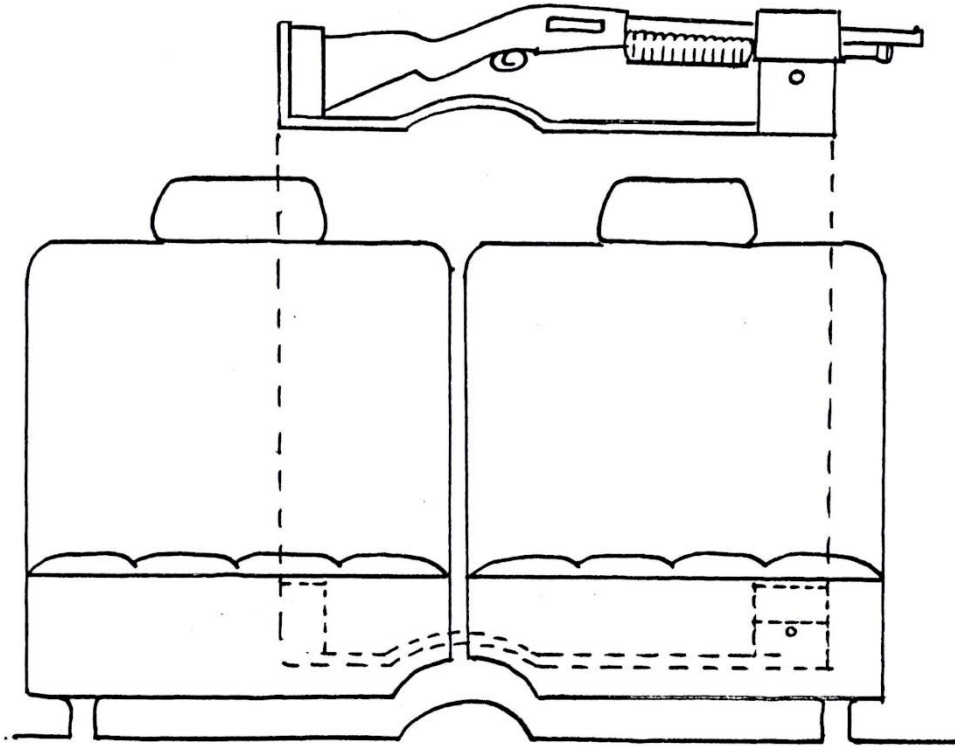

DRAWING OF NEW GUN RACKS TO BE
INSTALLED IN TROOP CARS FOR THE FIRST
TIME.

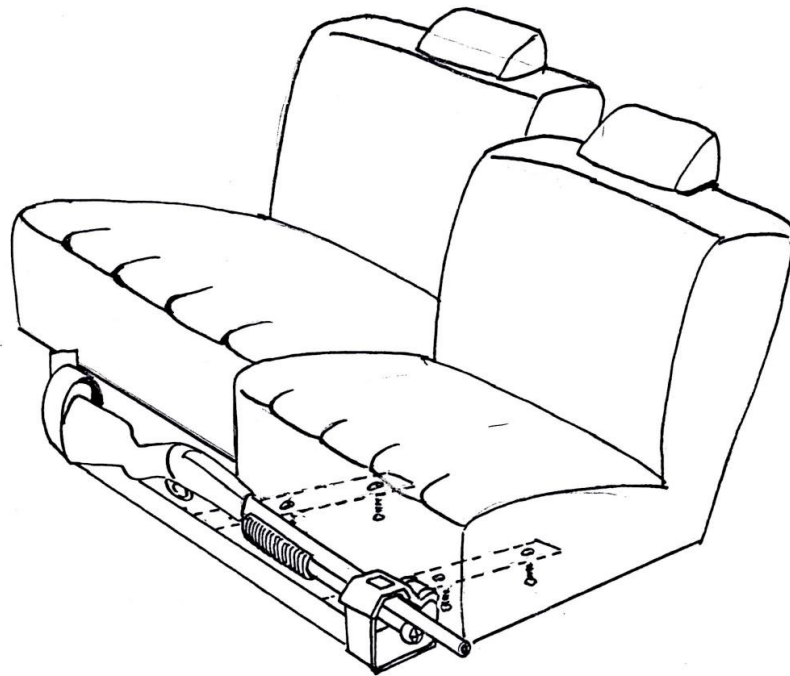

Gun-Rock